



高速光耦

High Speed Photo Coupler

**QXM6XX**

宁波群芯微电子股份有限公司

NINGBO QUNXIN MICROELECTRONICS CO., LTD.

中国 浙江省宁波杭州湾新区玉海东路 68 号

68 Yuhaidong Road, Hangzhou Bay New District, Ningbo, Zhejiang, China

### 概述 Description

QXM600、QXM601、QXM611 内部有一个 850nm 的 AlGaAs LED，其光学耦合到具有选通输出的超高速集成光电检测器。这些器件采用 5 引脚外形封装，符合标准封装外形。

The QXM600 QXM601 QXM611 optocoupler consists of a 850 nm AlGaAs LED, optically coupled to a very high speed integrated photo-detector logic gate with a strobable output. The devices are packaged in a 5-pin small outline package which conforms to the standard footprint.

### 特性 Features

- 输入-输出隔离电压 ( $V_{ISO}=3750$  Vrms )  
High isolation voltage between input and output ( $V_{ISO}=3750$  Vrms )
- 工作温度:  $-40^{\circ}\text{C}\sim 85^{\circ}\text{C}$   
Operating Temperature:  $-40^{\circ}\text{C}\sim 85^{\circ}\text{C}$
- 符合加强绝缘标准  
Meet reinforced insulation standards
- 符合安规标准: UL 1577, VDE DIN EN60747-5-5 (VDE 0884-5) , CQC11-471543-2022  
Meet Safety standard : UL 1577, VDE DIN EN60747-5-5 (VDE 0884-5) , CQC11-471543-2022

### 应用 Applications

- 接地回路消除  
Ground loop elimination
- LSTTL 转 TTL, LSTTL 或 5V CMOS  
LSTTL to TTL, LSTTL or 5-volt CMOS
- 线路接收器, 数据传输  
Line receiver, data transmission
- 开关电源  
Switching power supplies
- 计算机外围接口  
Computer-peripheral interface

### 真值表 Truth table

LED	VO
OFF	H
ON	L

### 封装和原理图 Package and Schematic Diagram

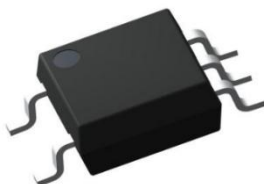

SOP5

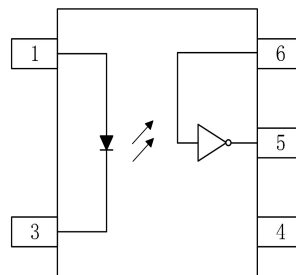

#### Pin Configuration

1. Anode
3. Cathode
4. GND
5. VO
6. VCC

注: 在引脚 4 和 6 之间必须连接一个 0.1uF 的旁路电容器。

Note: 0.1uF bypass capacitor must be connected between pins 4 and 6.



产品型号命名规则 Order Code

**QX M6XX - UN Y - W (V) (ZZ)**

①                      ②                      ③      ④                      ⑤                      ⑥                      ⑦

- ① 公司代码 Company Code (QX: 群芯 Qunxin)
- ② 产品系列 Product Series (XX: 00, 01, 11)
- ③ 框架类型 Lead Frame (Cu: 铜框架 Copper)
- ④ 树脂类型 Epoxy Type (H: 无卤 Halogen-free)
- ⑤ 封装形式 Package (S: SOP)
- ⑥ 器件工作温度范围 Device Operating Temperature Range (特殊范围需填或者空白 Special Range need to be filled in or left blank)
- ⑦ 内部补充代码 Internal Supplementary Code (数字或者空白 Number or None)

**印字信息 Marking Information**

- 印字中“”为群芯品牌 LOGO  
“”denotes LOGO
- 印字中的“XX”代表产品分档: 00、01、11  
“XX”denotes the classification: 00、01、11
- 印字中“Y”代表年份; A(2018),B(2019),C(2020).....  
“Y”denotes YEAR: A(2018), B(2019), C(2020).....
- 印字中“WW”代表周号  
“WW”denotes week’s number
- 印字中“N”代表星期几  
“N”denotes day of the week
- 印字中的“H”代表无卤  
“H”denotes Halogen-free

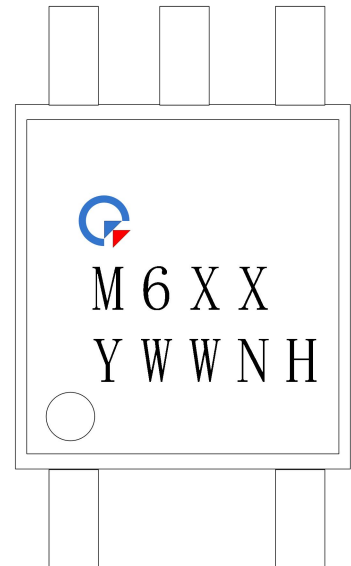

### 绝缘和安规信息 Insulation and Safety related specifications

项目 Item	符号 Symbol	数值 Value	单位 Unit	备注 Remark
爬电距离 Creepage Distance	L	> 5.0	mm	从输入端到输出端，沿本体最短距离路径 Measured from input terminals to output terminals, shortest distance path along body
电气间隙 Clearance Distance	L	> 5.0	mm	从输入端到输出端，通过空气的最短距离 Measured from input terminals to output terminals, shortest distance through air
绝缘距离 Insulation Thickness	DTI	> 0.4	mm	发射器和探测器之间的绝缘厚度 Insulation thickness between emitter and detector
峰值隔离电压 Peak Isolation Voltage	$V_{IORM}$	600	$V_{peak}$	DIN/EN/IEC EN60747-5-5
瞬态隔离电压 Transient isolation voltage	$V_{IOTM}$	5000	$V_{peak}$	DIN/EN/IEC EN60747-5-5
隔离电压 Isolation Voltage	$V_{iso}$	> 3750	$V_{rms}$	For 1 min

### 极限参数 Absolute Maximum Ratings ( $T_a=25^{\circ}C$ )

参数 Parameter		符号 Symbol	额定值 Rating	单位 Unit
发射端 Input	正向电流(平均) DC/Average Forward Input Current	$I_{F(avg)}$	25	mA
	正向峰值电流 (50%占空比, 1ms p.w.) Peak input current (50% duty cycle, 1 ms p.w.)	$I_{F(pk)}$	50	mA
	反向电压 Reverse Voltage	$V_R$	5	V
	功耗 Power Dissipation	$P_D$	100	mW
接收端 Output	电源电压 Supply Voltage	$V_{CC}$	7.0	V
	输出电流 Output Current	$I_O$	50	mA
	输出电压 Output Voltage	$V_O$	7.0	V
	集电极功耗 Collector Power Dissipation	$P_C$	85	mW
工作温度 Operating Temperature	$T_{opr}$	-40~+85	$^{\circ}C$	
存储温度 Storage Temperature	$T_{stg}$	-55~+125	$^{\circ}C$	
焊接温度 Soldering Temperature	$T_{sol}$	260	$^{\circ}C$	

### 推荐工作条件 Recommended Operating Conditions

参数 Parameter	符号 Symbol	最小值 Min.	最大值 Max.	单位 Unit
电源电压 Supply Voltages	$V_{CC}$	2.7	5.5	V
低电平输入电流 Input Current, Low level	$I_{FL}$	0	250	$\mu A$
高电平输入电流 Input Current, High level	$I_{FH}$	6	15	mA
输出上拉电阻 Output Pull-up Resistor	$R_L$	330	4k	$\Omega$
操作温度 Operating Temperature	$T_a$	-40	+85	$^{\circ}C$

### 产品特性参数 Electro-optical Characteristics ( $T_a=25^{\circ}C$ )

参数 Parameter	符号 Symbol	条件 Condition	最小 Min.	典型 Typ.	最大 Max.	单位 Unit	
发射端 Input	正向电压 Forward Voltage	$V_F$	$I_F=10mA$	-	1.33	1.8	V
	反向击穿电压 Reverse Breakdown Voltage	$BV_R$	$I_R=10\mu A$	5	-	-	V
	电容 Capacitance	$C_{IN}$	$V=0, f=1MHz$	-	70	-	pF
	正向电压的温度系数 Diode Temperature Coefficient	$\Delta V_F/\Delta T_A$	$I_F=10mA$	-	-1.9	-	mV/ $^{\circ}C$
接收端 Output	高电平电源电流 High Level Supply Current	$I_{CCH}$	$V_{CC}=5.5V, I_F=0mA$	-	6.0	9	mA
	低电平电源电流 Low Level Supply Current	$I_{CCL}$	$V_{CC}=5.5V, I_F=10mA$	-	7.5	10	mA
传输特性 Transfer Characteristics	高电平输出电流 HIGH Level Output Current	$I_{OH}$	$V_{CC}=5.5V$ $V_O=5.5V$ $I_F=250\mu A$	-	2.1	30	$\mu A$
	低电平输出电压 LOW Level Output Voltage	$V_{OL}$	$V_{CC}=5.5V$ $I_F=5mA$ $I_{CL}=13mA$	-	0.4	0.6	V
	输入阈值电流 Input Threshold Current	$I_{TH}$	$V_{CC}=5.5V$ $V_O=0.6V$ $I_{OL}=13mA$	-	2.4	5	mA
隔离电压 Isolation Voltage	$V_{ISO}$	$R_H<50\%$ $T_A=25^{\circ}C$ $I_{I-O}\leq 50\mu A$	3750	-	-	$V_{RMS}$	
电阻 (输入到输出) Resistance (Input to Output)	$R_{I-O}$	$V_{I-O}=500V$	-	$10^{12}$	-	$\Omega$	
电容 (输入到输出) Resistance (Input to Output)	$C_{I-O}$	$f=1MHz$	-	0.6	-	pF	

### 开关特性 Switching Specification ( $T_A=25^\circ\text{C}, I_F=7.5\text{mA}, V_{CC}=5.0\text{V}$ )

参数 Parameter	符号 Symbol	条件 Condition	最小 Min.	典型 Typ.	最大 Max.	单位 Unit	
输出高电平传播延迟 Propagation Delay Time to High Output Level	$T_{PLH}$	$C_L=15\text{pF}$ $R_L=350\Omega$ $T_A=25^\circ\text{C}$	-	41	100	ns	
输出低电平传播延迟 Propagation Delay Time to Low Output Level	$T_{PHL}$		-	50	100	ns	
脉宽失真 Pulse Width Distortion	$ T_{PHL}-T_{PLH} $		-	9	35	ns	
输出上升时间(10% - 90%) Output Rise Time (10 to 90%)	$t_r$		-	40	-	ns	
输出下降时间(90% - 10%) Output Fall Time (90 to 10%)	$t_f$		-	10	-	ns	
传播延迟偏斜 Propagation Delay Skew	$t_{psk}$		-	-	40	ns	
输出高电平共模瞬态抑制 Common Mode Transient Immunity at High Output Level	M600	$ CM_H $	$T_A=25^\circ\text{C}, I_F=0\text{mA}$ $ V_{CM} =10\text{V(Peak)}$ $V_{OH}=2.0\text{V}, R_L=350\Omega$	-	-	-	V/ $\mu\text{s}$
	M601		$T_A=25^\circ\text{C}, I_F=0\text{mA}$ $ V_{CM} =50\text{V(Peak)}$ $V_{OH}=2.0\text{V}, R_L=350\Omega$	5000	-	-	
	M611		$T_A=25^\circ\text{C}, I_F=0\text{mA}$ $ V_{CM} =1000\text{V(Peak)}$ $V_{OH}=2.0\text{V}, R_L=350\Omega$	20000	-	-	
输出低电平共模瞬态抑制 Common Mode Transient Immunity at Low Output Level	M600	$ CM_L $	$I_F=7.5\text{mA}, V_{OL}=0.8\text{V}$ $R_L=350\Omega, T_A=25^\circ\text{C}$ $ V_{CM} =10\text{V(Peak)}$	-	-	-	V/ $\mu\text{s}$
	M601		$I_F=7.5\text{mA}, V_{OL}=0.8\text{V}$ $R_L=350\Omega, T_A=25^\circ\text{C}$ $ V_{CM} =50\text{V(Peak)}$	5000	-	-	
	M611		$I_F=7.5\text{mA}, V_{OL}=0.8\text{V}$ $R_L=350\Omega, T_A=25^\circ\text{C}$ $ V_{CM} =1000\text{V(Peak)}$	20000	-	-	

**典型光电特性曲线 Typical Electro-Optical Characteristics Curves**

Fig.1 Low-level voltage vs. Ambient temperature

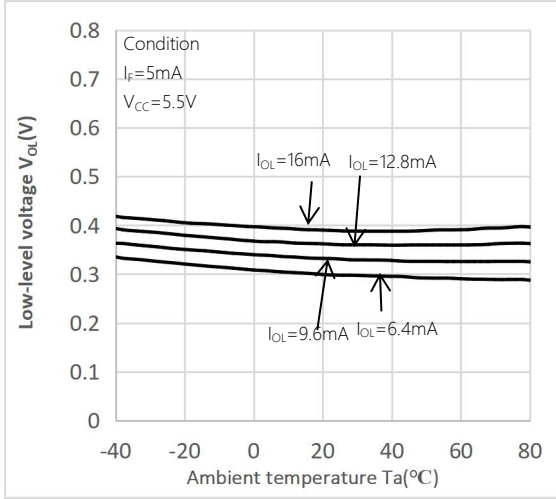

Fig.2 Forward current voltage vs. Forward voltage

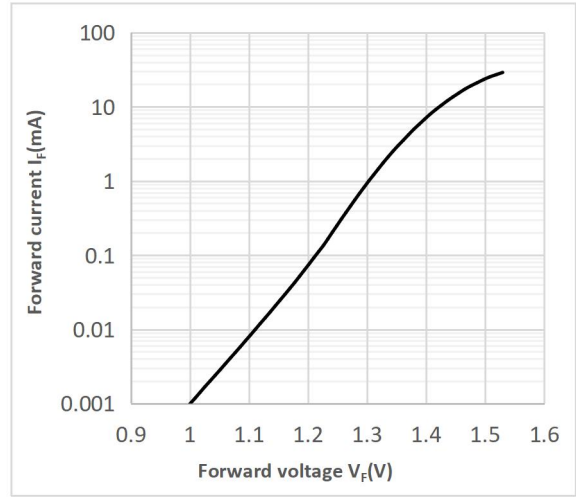

Fig.3 Switch time vs. Forward current

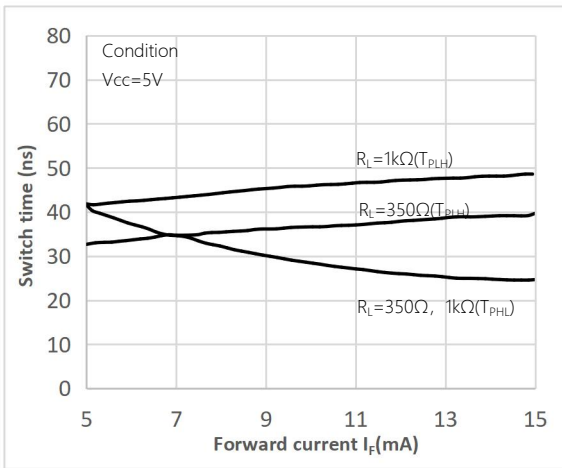

Fig.4 Low-level output current vs. Ambient temperature

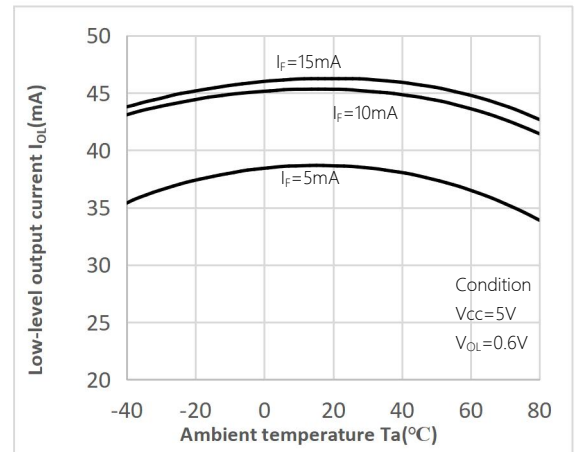

Fig.5 Starting current vs. Ambient temperature

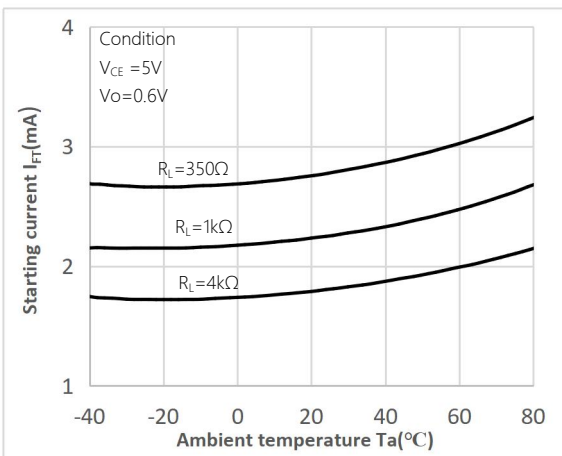

Fig.6 Output voltage vs. Input Forward current

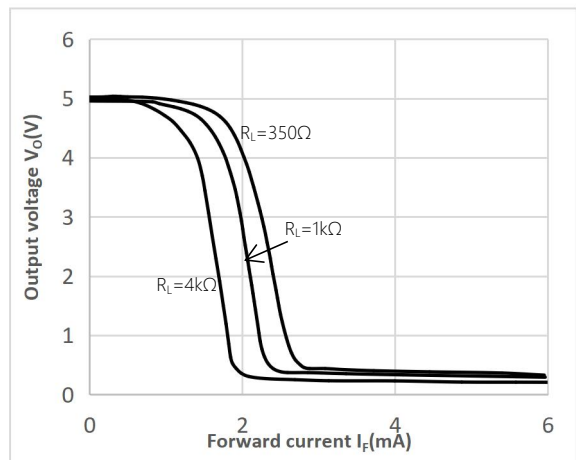

Fig.7 Pulse-width distortion vs. Ambient temperature

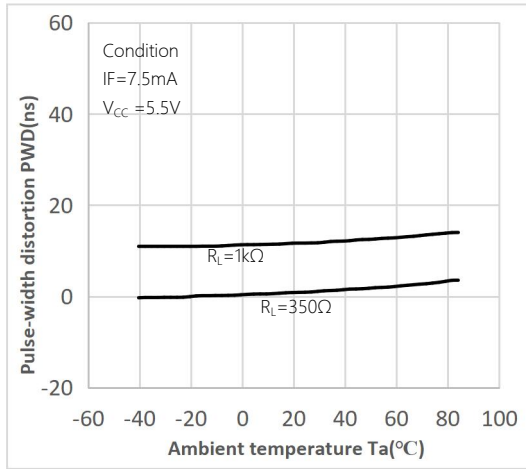
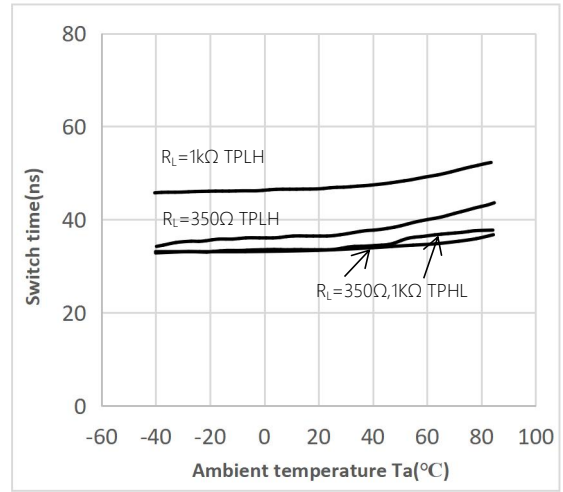
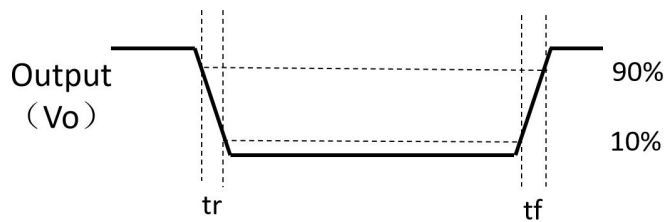
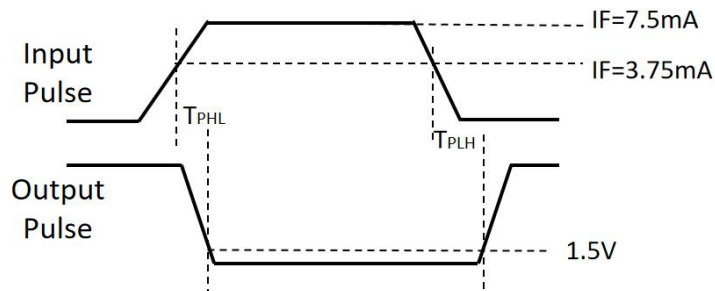
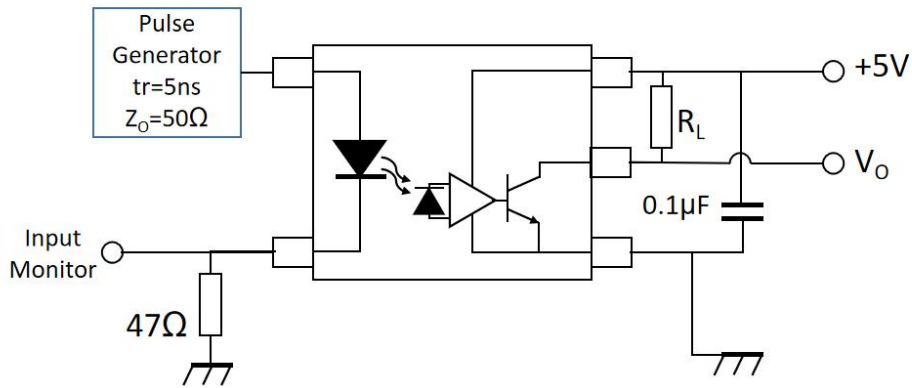

Fig.8 Switch time vs. Ambient temperature



**开关时间测试电路 Switching Time Test Circuit**





**CMR 测试电路 Test Circuit for Common Mode Transient Immunity**

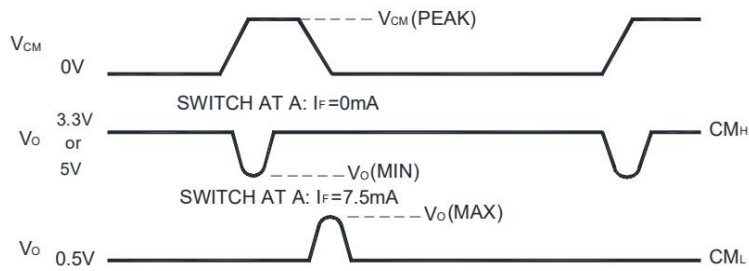
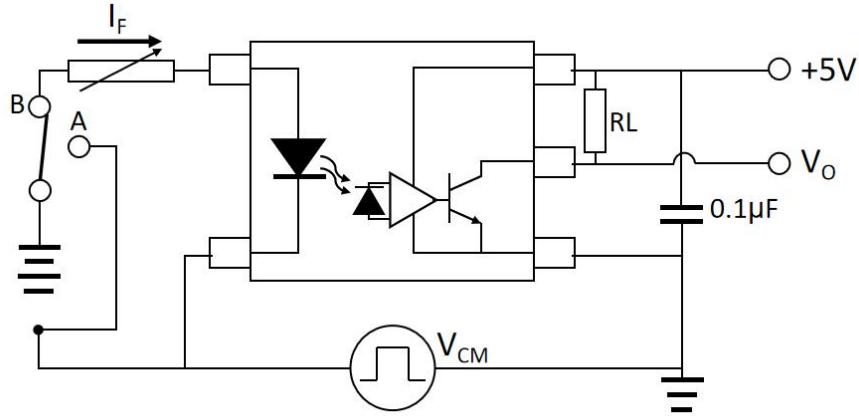

**外形尺寸 Outline Dimensions**

SOP5

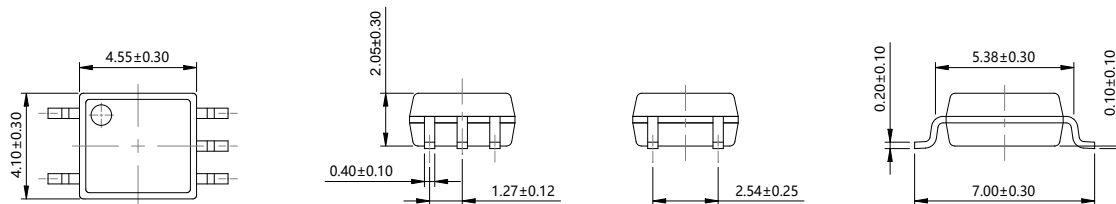

单位 Unit: mm

**建议焊盘布局 Recommended Pad Layout**

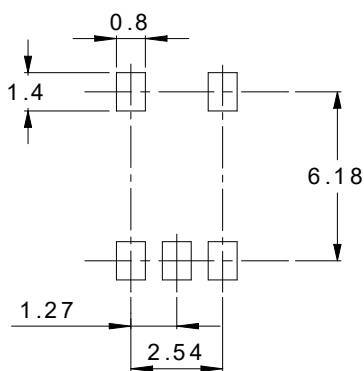

单位 Unit: mm

注：上图为产品正视图。

Note: The picture above is the front view of the product.

回流焊温度曲线图 Solder Reflow Profile

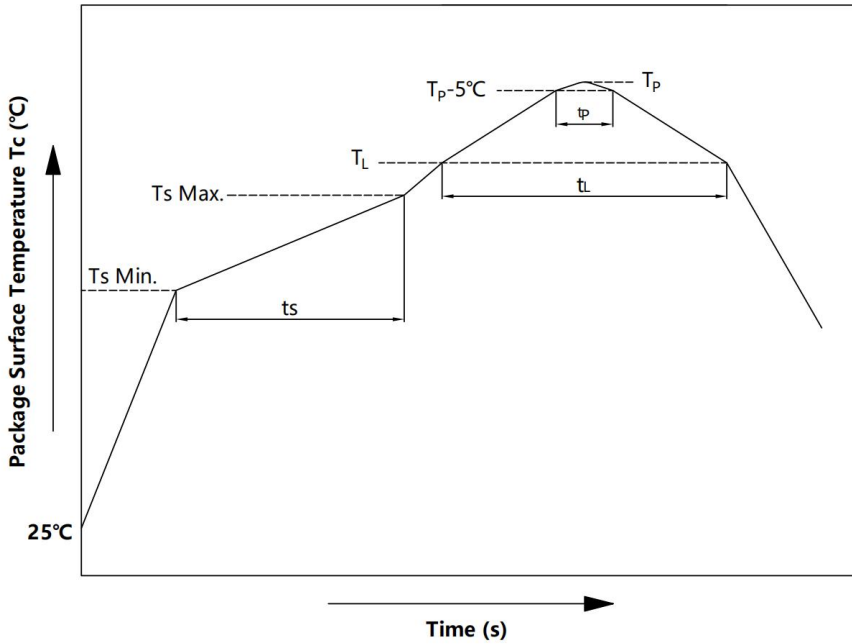

项目 Item	符号 Symbol	最小值 Min.	最大值 Max.	单位 Unit
预热温度 Preheat Temperature	$T_s$	150	200	$^\circ\text{C}$
预热时间 Preheat Time	$t_s$	60	120	s
升温速率 Ramp-Up Rate ( $T_L$ to $T_P$ )	-	-	3	$^\circ\text{C}/\text{s}$
液相线温度 Liquidus Temperature	$T_L$	217		$^\circ\text{C}$
时间高于 $T_L$ Time Above $T_L$	$t_L$	60	150	s
峰值温度 Peak Temperature	$T_P$	-	260	$^\circ\text{C}$
$T_c$ 在 $(T_P-5)$ 和 $T_P$ 之间的时间 Time During Which $T_c$ Is Between $(T_P-5)$ and $T_P$	$t_p$	-	30	s
降温速率 Ramp-down Rate ( $T_P$ to $T_L$ )	-	-	6	$^\circ\text{C}/\text{s}$

注 Note:

建议在所示的温度和时间条件下进行回流焊，最多不能超过三次；

Reflow soldering is recommended at the temperatures and times shown, no more than three times;

**波峰焊温度曲线图 Wave Soldering Profile**

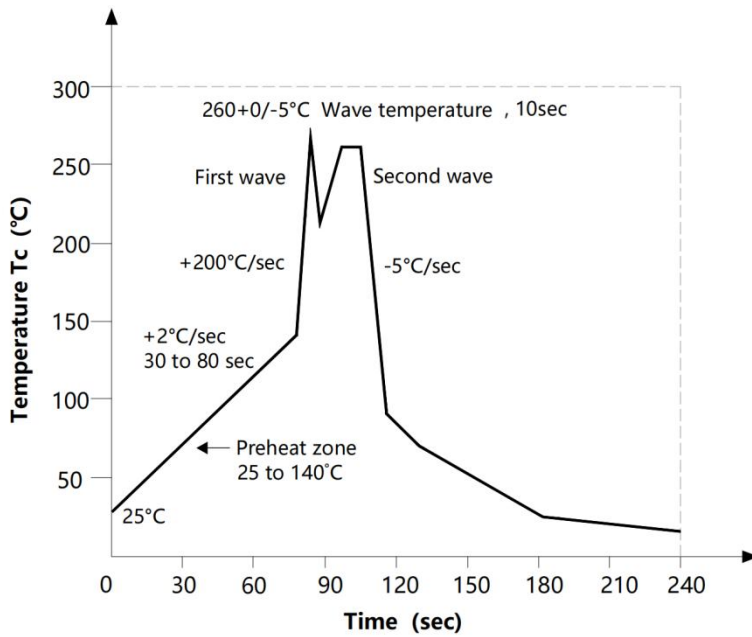

**手工烙铁焊接 Soldering with hand soldering iron**

- A. 手工烙铁焊仅用于产品返修或样品测试;  
Hand soldering iron is only used for product rework or sample testing;
- B. 手工烙铁焊要求: 温度  $360^{\circ}\text{C} \pm 5^{\circ}\text{C}$ , 时间  $\leq 3\text{s}$ 。  
Hand soldering iron requirements: Temperature:  $360^{\circ}\text{C} \pm 5^{\circ}\text{C}$ , within 3s.

**包装 Packing**

■ 汇总表 Summary table

封装形式	包装方式	盘数量	盒数量	箱数量	静电袋规格	盒规格	箱(双瓦楞)规格	备注
SOP5	编带 (φ330mm 蓝)	3k /盘	2 盘/盒	10 盒/箱	450*390*0.1mm	340*60*340mm	620*360*365mm	保护带 200mm (min)
Package Type	Packing Form	Quantity per Reel	Quantity per Box	Quantity per Carton	Antistatic Bag Specification	Box Specification	Carton Specification	Note
SOP5	Reel(φ330mm Blue)	3k pcs/reel	2 reels /box	10 boxes /ctn	450*390*0.1mm	340*60*340mm	620*360*365mm	Guard band 200mm min.

■ 编带包装 Tape & Reel

- 1) 每卷数量: 3000 只。  
Qty/reel: 3000 pcs.
- 2) 每箱数量: 60000 只。  
Qty/ctn: 60000 pcs.
- 3) 内包装: 每盒 2 盘。  
Inner packing: 2 reels/box.
- 4) 示意图 Schematic:

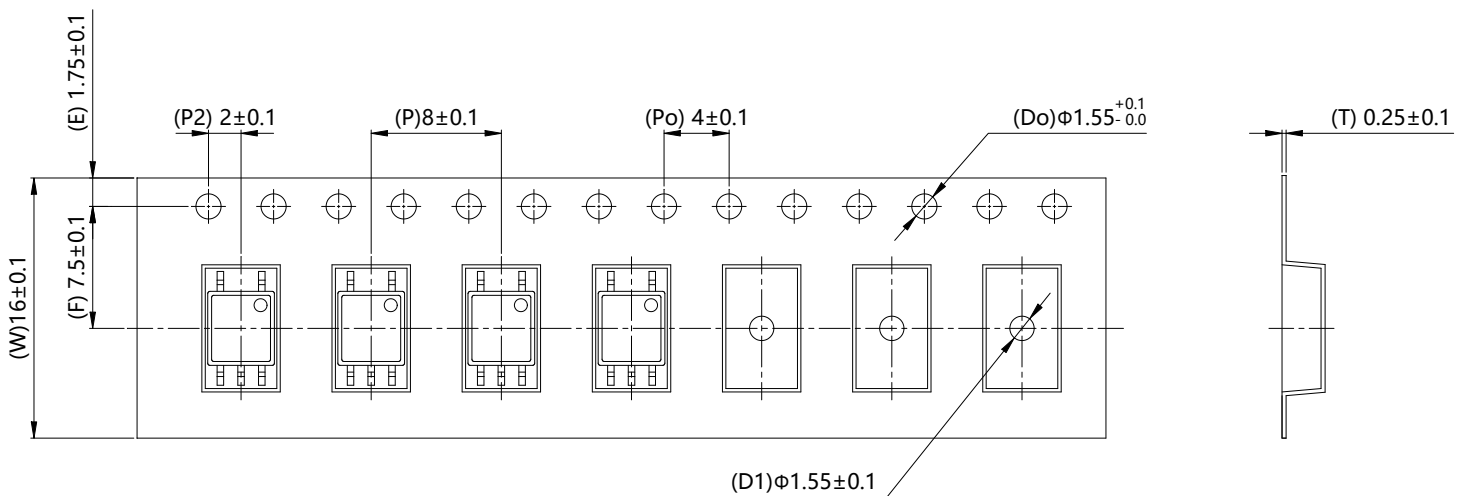

单位 Unit: mm

### **注意 Attention**

- 群芯持续不断改进质量、可靠性、功能或设计，保留此文件更改的权利恕不另行通知。  
QUNXIN continuously improve quality, reliability, function and design. We reserve the right to change this document without prior notice.
- 请遵守产品规格书使用，群芯不对使用时不符合产品规格书条件而导致的质量问题负责。  
Please use in accordance with the product specification. QUNXIN is not responsible for the quality problems caused by non-compliance with the product specifications.
- 对于需要高可靠性或安全性的设备/装置需求，请联系我们的销售人员。  
For equipment/devices requiring high reliability or safety, please contact our sales representatives.
- 当需要用于任何“特定”应用时，请咨询我们的销售人员。  
When requiring a device for any “specific” application, please contact our sales in advice.
- 如对文件中表述的内容有疑问，欢迎联系我们。  
If you have any questions about the contents of the document, please contact us.